

Monitoring coastal pollution by using an integrated low-cost device

EGU2020-1946

Daniele Piazzolla^{1,2}, Andrea Terribili^{2,3}, Simone Bonamano², Sergio Scanu^{1,2}, Marco Marcelli^{1,2}, Giancarlo Della Ventura^{4,5}, Alessandra Conte^{4,5}, Federico Lucci⁴, and Augusto Marcelli⁵



PURPOSE OF THE STUDY

Coasts are extremely sensitive areas and are internationally considered “hotspot” of environmental contamination. The presence of multiple human activities in these areas frequently lead to the potential increase in organic and inorganic pollutants. In particular, industrial and maritime activities, tourism, recreational activities, aquaculture and fishing contribute to the pollutants release in the coastal environments.

The project is particularly aimed at designing and testing of reliable low-cost devices (Gozzi et al., 2015, 2017) able to provide both the amount and typology of solid particles spread in the environment. As a first step, the air quality inside the Civitavecchia harbor has been monitored for six months by measuring the content of PM₁, PM_{2.5}, and PM₁₀ simultaneously to environmental parameters such as air temperature and humidity. The sensing station (Della Ventura et al., 2017) was equipped with a filtering set-up able to collect the solid load in the atmosphere with dimension > 400 nm. The filters were periodically removed from the station and studied by combining microscopic (optical and electron), spectroscopic (IR, Raman) and microchemical (SEM-EDS) techniques for a full characterization of microparticles typologies. Collected information, augmented by environmental (wind, rain) data from local broadcasting stations provides a valuable tool for assessing the contribution of anthropic (industrial and maritime) activities to the pollution in this coastal area.

Gozzi, F., Della Ventura, G., Marcelli, A. (2015) Mobile monitoring of particulate matter: State of art and perspectives. *Atmospheric Pollution Research*, 7, 228-234. DOI:10.1016/j.apr.2015.09.007; Gozzi, F., Della Ventura, G., Marcelli, A., Lucci, F. (2017) Current status of particulate matter pollution in Europe and future perspectives: a review. *Journal of Materials and Environmental Science*, 8, 1901-1909. ISSN: 2028-2508; Della Ventura, G., Gozzi, F., Marcelli, A. (2017) The MIAMI project: design and testing of an IoT lowcost device for mobile monitoring of PM and gaseous pollutants. *Superstripe Press, Science Series*, 12, 41-44, ISBN 9788866830764.

STUDY AREA



The northern Latium coastal area (northern Tyrrhenian Sea, Italy) hosts several industrial activities of national and international relevance: the Port of Civitavecchia, one of the most important hub for cruise and commercial traffic in the Mediterranean Sea, the Torrevaldaliga Nord coal-fired power plant of the national energy company (ENEL), and the Tirreno Power combined cycle (gas-fueled) power plant. All these activities strongly contribute to the increase of pollutant load to the land as well as marine coastal environment.

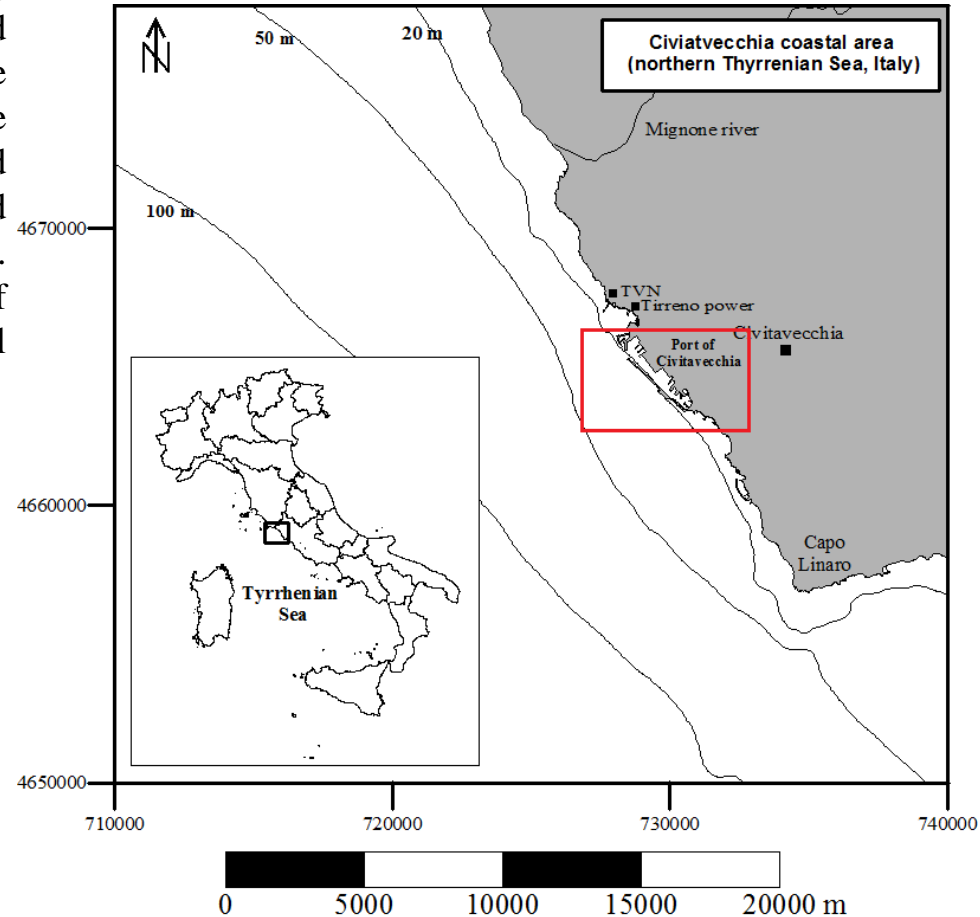

The innovative low-cost device for monitoring coastal air pollution has been tested for 6 months, located inside the Port of Civitavecchia, on the building that houses the Laboratory of Experimental Oceanology and Marine Ecology (LOSEM) of the University of Tuscia (Department of Ecological and Biological Sciences)

LOW-COST DEVICE FOR AIR POLLUTION MONITORING

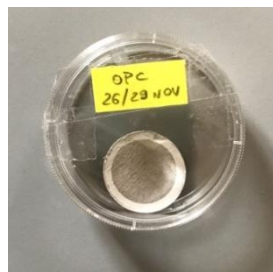

Direct analysis
of airborne particles

SEM/EDS analysis of trapped particles



OPC-N3 (Alphasense Ltd)

Quantitative assessment of atmospheric pollution

- Particulate matter (PM1 -PM2.5 -PM10)
- Sample Flow rate (SFR)
- Sample Period (SP)
- Temperature (T; °C)
- Humidity (RH; %)

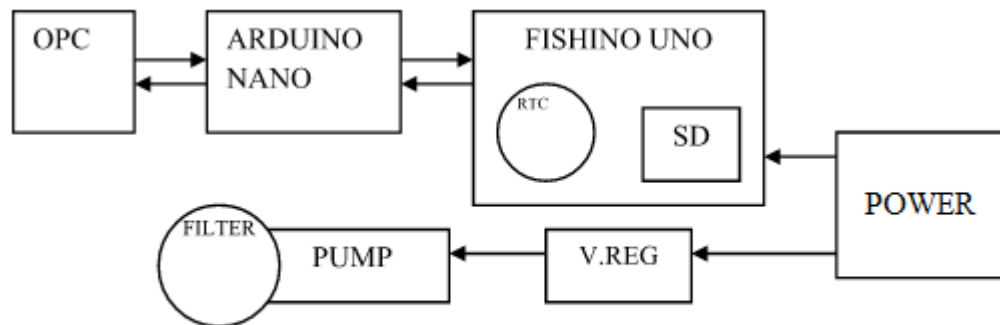

The system is based on Arduino platform (Fishino Uno and Arduino Nano boards). The OPC-N3 sensor (Alphasense Ltd) detects PM1, PM2.5, PM10, temperature, humidity, and particle bins. Arduino Nano controls the particulate sensor that provides the result every 10 seconds and send them to a Fishino Uno board (equipped with a Real-time clock and an SD card for storing data) via I2C protocol. A micro-pump system collects the air and the suspended particles are trapped on a fibreglass filter for successive analysis.

PRELIMINARY RESULTS



PM1 ($\mu\text{g}/\text{m}^3$) 29/11/2019-30/12/2019

One of the advantages of this device is its extreme portability and the possibility of being oriented in all directions.



The first tests were conducted by orienting the device, that is located south of most of the port cruise and commercial docks and power plants, towards N/NW. For this reason, the data appear to be strongly influenced by the wind direction rather than by the wind speed.

High concentrations of PM1 (data from 29/11/2019 to 30/12/2019) have been recorded mainly with the presence of winds coming from N/NW

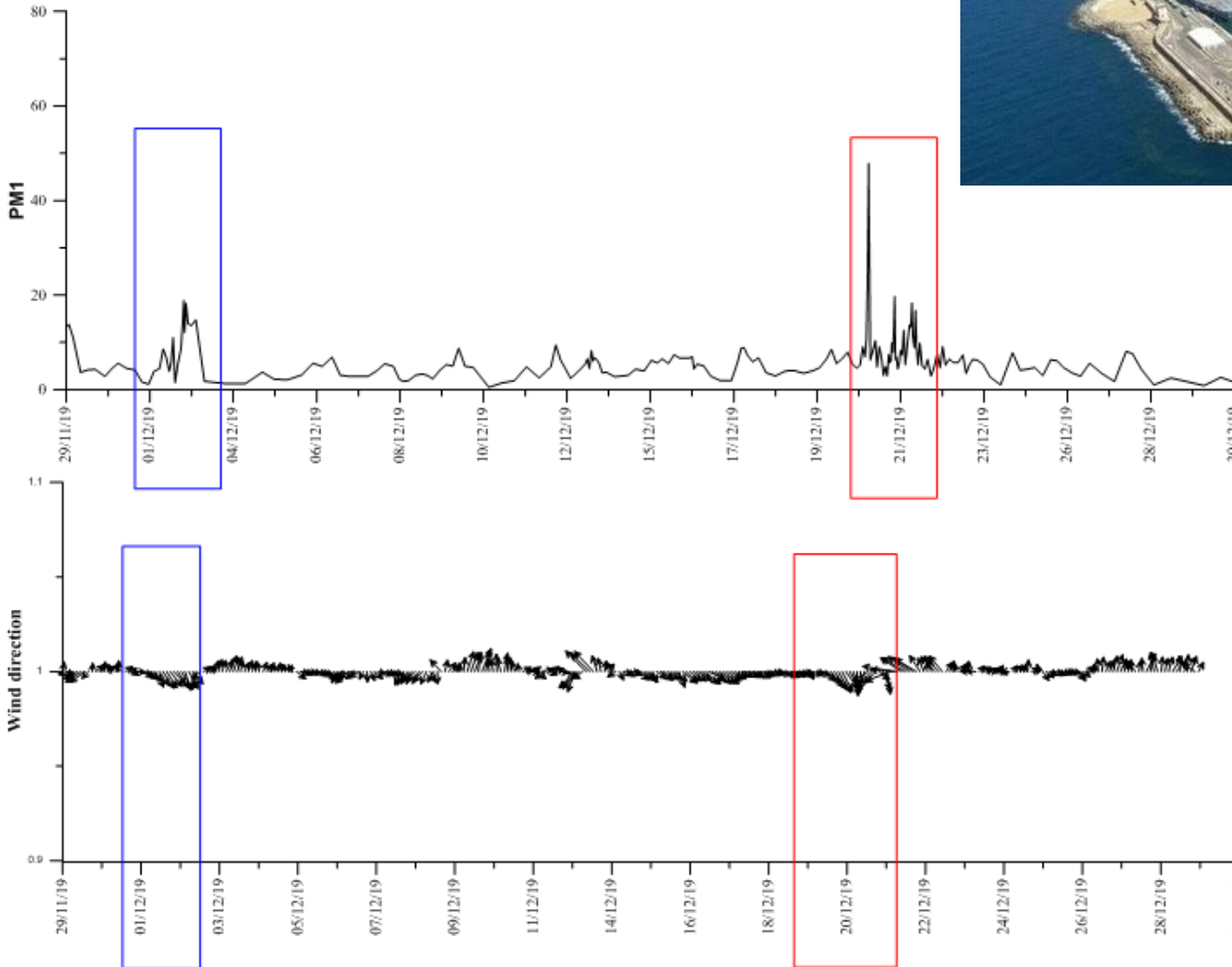

SEM-EDS characterization

Typical SEM photomicrograph and EDS spectra of different airborne particles sampled in the Port of Civitavecchia consisting of Ca-Fe silicates, possibly Fe-sulfides and carbon, probably deriving from combustion process.

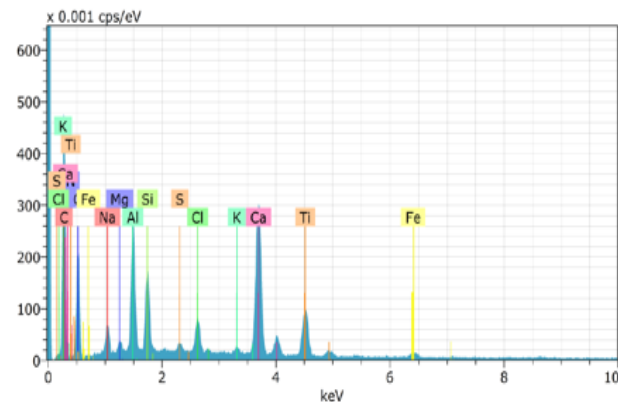
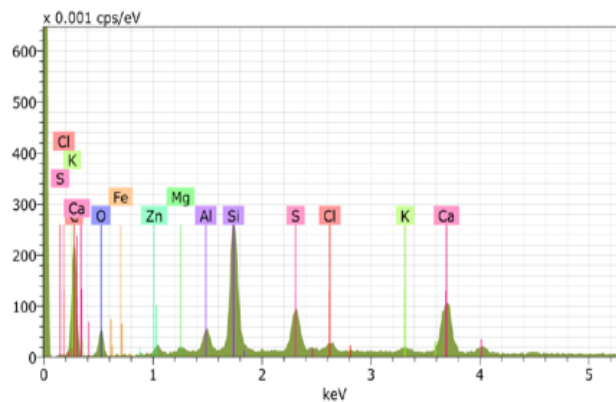
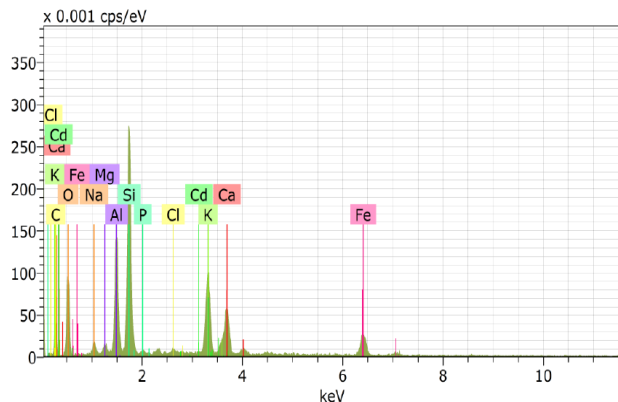
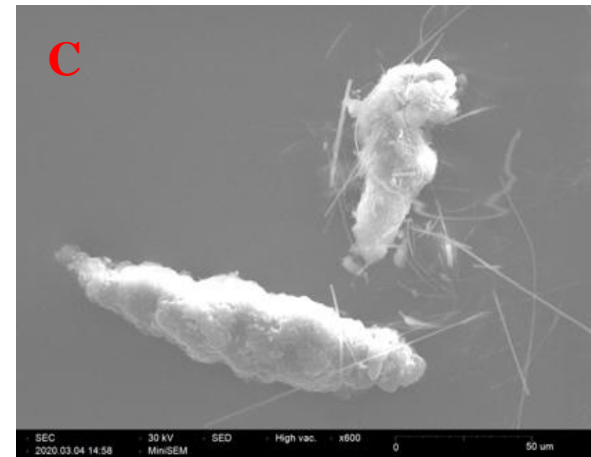
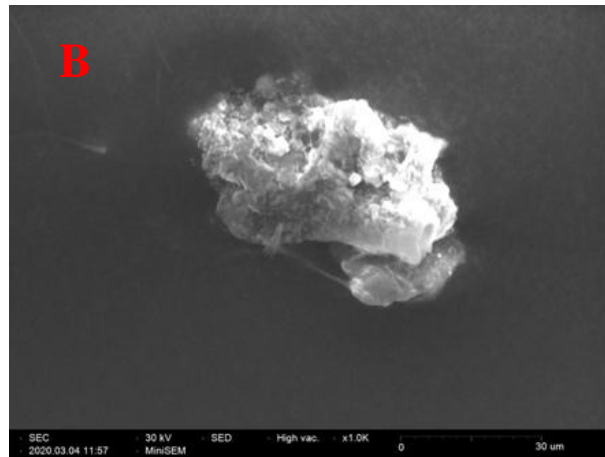
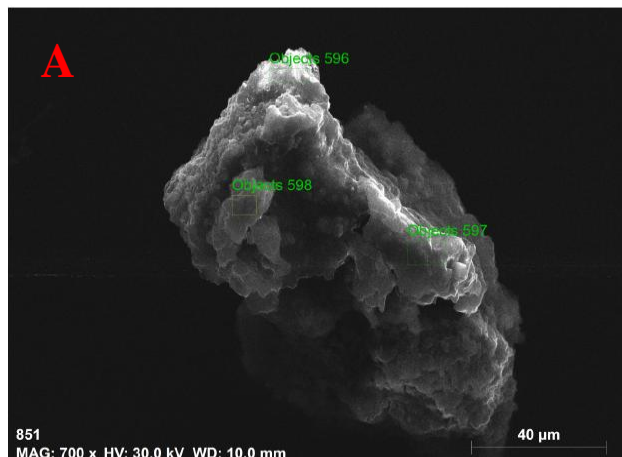

FTIR spectroscopy

FTIR spectroscopy was mainly used to characterize organic compounds, found to be relatively common in the particulate deposited on the filters. Below there is an example of a fibrous particle and the relative IR spectrum.

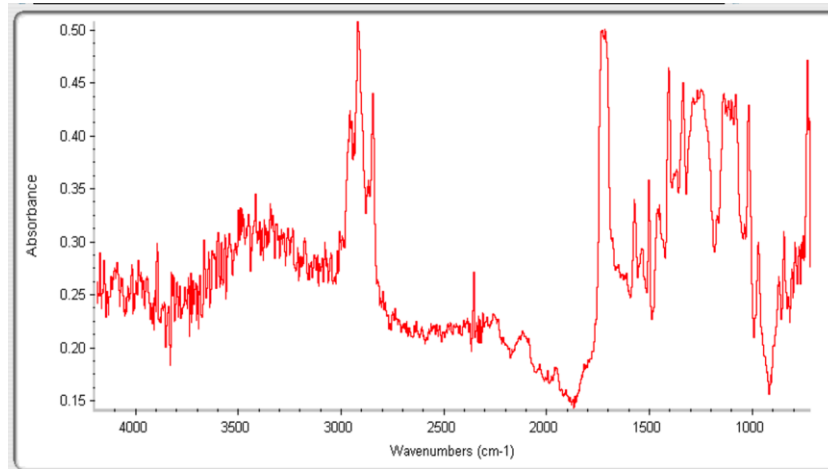
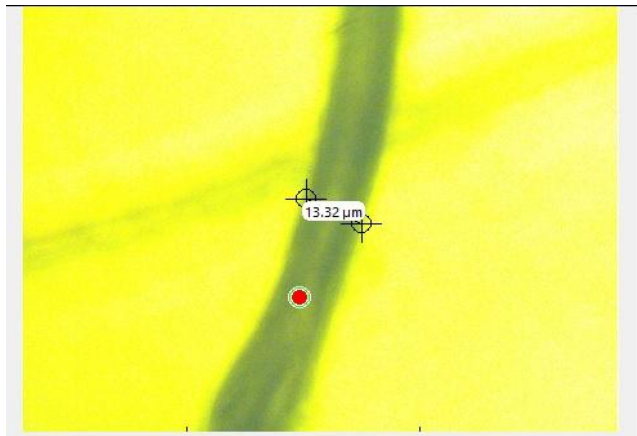

FUTURE PERSPECTIVES

- The orientation of the device will be tested together with an omni-directional exposure.
- Wi-Fi and GSM modules will be integrated into the device.
- The project involves the installation of other devices throughout the Civitavecchia area in order to obtain a more accurate mapping of atmospheric pollution.
- The device will be tested in other environments.

Thanks for your attention